



WINDOW TECHNOLOGY
DOOR TECHNOLOGY
AUTOMATIC ENTRANCE SYSTEMS
BUILDING MANAGEMENT SYSTEMS



FOR ALUMINIUM WINDOWS AND BALCONY-DOORS WITH SASH GROOVE 15/20

The Tilt&Turn hardware range ALU-JET 10

Securing technology for you



Design freedom thanks to the modular ALU-JET 10 hardware

ALU-JET features state-of-the-art technology which means it can meet the high expectations for windows and moving facade elements in commercial construction projects. The ALU-JET 10 central locking system is the modular basis for all special designs such as Parallel-Projecting, Horizontal-Pivot or Vertical-Pivot windows, as well as Swing&Slide and Top-Hung windows. Safety through tested quality: The ALU-JET is tested according to EN 13126-8 and certified by ift according to QM 328.





ALU-JET 10 central locking system



Product characteristics

- Universally applicable for all opening methods
- Uniform Ø 10 mm connecting rod holes for the coupling points and locking cams/handle connectors
- Burglar inhibition freely configurable: Further locking points can be added at any position of the connecting rod
- Leaf weights up to 300 kg possible
- Efficient installation:
 - toolless mounting of corner drives
 - only one continuous connecting rod per sash side
 - fixed connecting rod length on hinge side and bottom sash side (prefabrication possible)
- Non-handed mishandling device integrated in the corner-drive

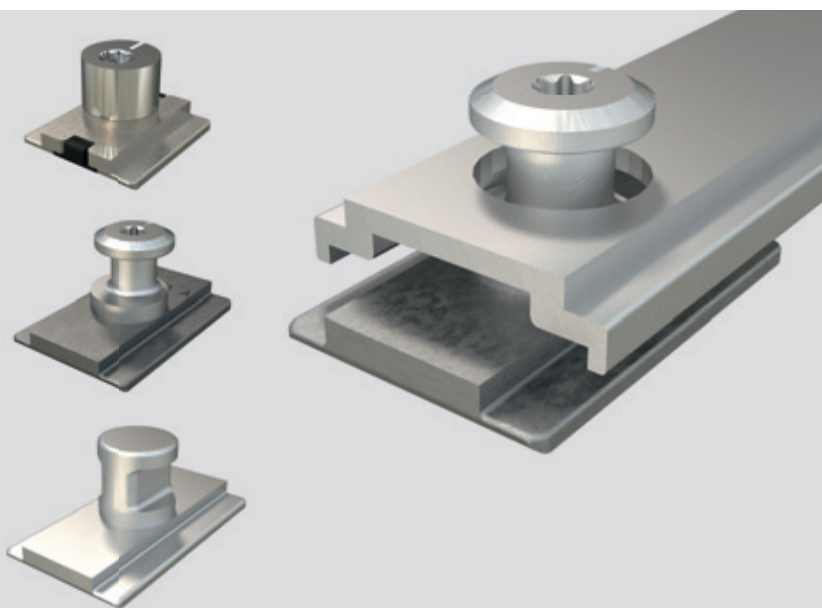

Security with a system

Anti-jimmy locking cams insertable from underneath, suitable for all resistance classes from basic security to RC3 according to EN 1627

Product overview

Designation	Rebate clearance [mm]	Frame grooves [mm]			Tested load-bearing capacity [kg]	Sash width [mm]	Sash height [mm]
		10/14	12/15	14/18			
ALU-JET 10 central locking system with ALU-JET 510 surface-mounted hinge-side	11.5	10/14	12/15	14/18	80 [1] 100 [2]	395-1600	500-2400
ALU-JET 10 central locking system with ALU-JET 710 surface-mounted hinge-side	11.5	10/14	12/15	14/18	130	410-1700	500-2800
ALU-JET 10 central locking system with ALU-JET CC610 concealed hinge-side	11.5	10/14	12/15*	14/18	150	500-1600	500-2800

[1] Windows: SRW 1300 mm x SRH 1200 mm | [2] Balcony-doors: SRW 900 mm x SRH 2300 mm | * on request
For all stated weights and dimensions, please refer to our application diagrams and the manufacturer's profile information!
For more information: www.g-u.com

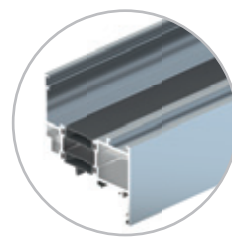

ALU-JET 510 and ALU-JET 710 surface-mounted hinge-sides



ALU-JET 510

Elegant aesthetics
The standard solution
for all standard formats
available on the market



Product characteristics

- Universally applicable for Tilt&Turn, Tilt-First, Turn-Only and Tilt-Only sashes
- Efficient mounting through modularly preassembled modules
- Extensive range of surface finishes
- All components are non-handed
- Convenient hardware setting options
- Maintenance-free stay-hinges and corner-hinges



ALU-JET 710

Tried-and-tested technology

The project solution
for heavy window elements

Technical data

Designation	Rebate clearance [mm]	Frame grooves [mm]	Hinge-passage [mm]	Tested hardware load-bearing capacity [kg]	Sash width [mm]	Sash height [mm]
ALU-JET 510 surface-mounted hinge side	11.5	10/14 12/15 14/18	3.5	80 [1] 100 [2]	395–1600	500–2400
ALU-JET 710 surface-mounted hinge side	11.5	10/14 12/15 14/18	3.0	130	410–1700	500–2800

[1] Windows: SRW 1300 mm x SRH 1200 mm | [2] Balcony-doors: SRW 900 mm x SRH 2300 mm
For all stated weights and dimensions, please refer to our application diagrams and the manufacturer's profile information!
For more information: www.g-u.com

ALU-JET CC610 concealed hinge-side

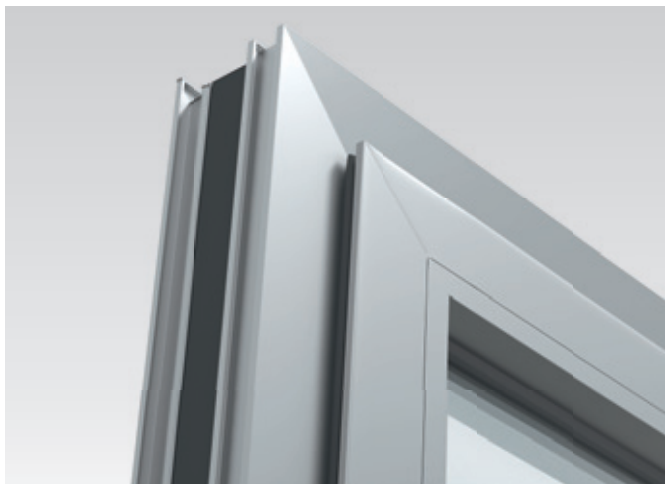

Product characteristics

- Universally applicable for Tilt&Turn, Tilt-First, Turn-Only and Tilt-Only sashes
- Sash weights up to 150 kg possible without additional components
- For hinge-side locking on Turn-Only sashes, the central locking system can be guided through the Turn-Only stay-guide

Reduced warehousing costs

Two stay sizes to cover all sash widths

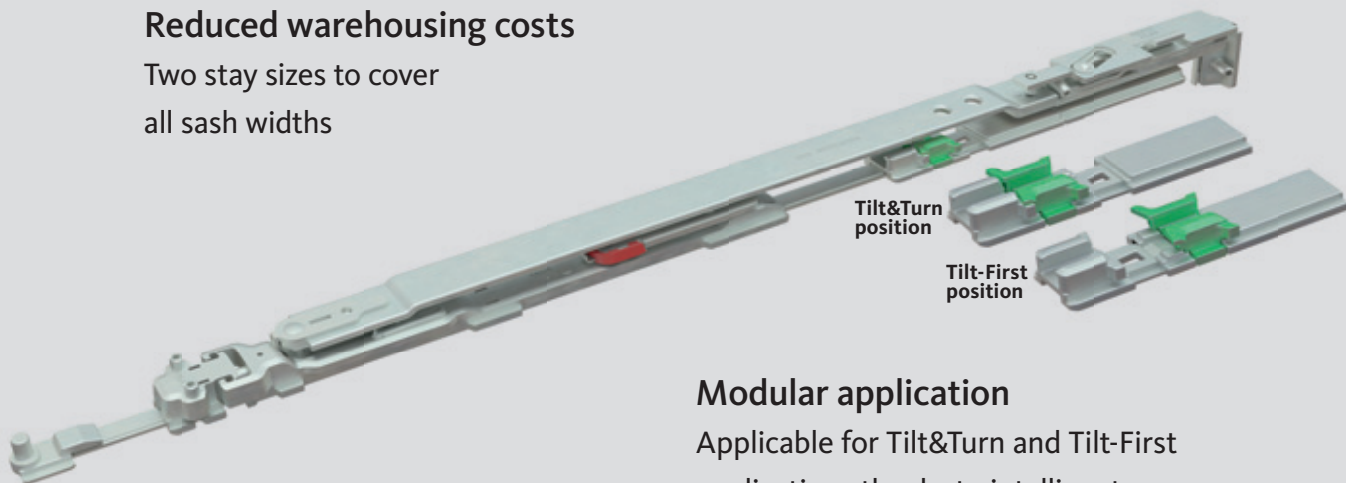

Modular application

Applicable for Tilt&Turn and Tilt-First applications thanks to intelligent clamping technology

Product overview

Designation	Rebate clearance [mm]	Frame grooves [mm]	Tested hardware load-bearing capacity [kg]	Sash width [mm]	Sash height [mm]
ALU-JET CC610 concealed hinge-side	11.5	10/14 12/15* 14/18	150	500-1600	500-2800

* on request
For all stated weights and dimensions, please refer to our application diagrams and the manufacturer's profile information!
For more information: www.g-u.com

ALU-JET S800

The project solution for heavy facade elements up to 300 kg



Product characteristics

- Applicable for Turn-Only and Tilt-Only sashes
- Opening angle 180°
- For profile systems with hinge-passage from 7 mm
- Extensive range of surface finishes
- Maintenance-free, high-performance polymer bearings



Product overview

Designation	Rebate clearance [mm]	Frame grooves [mm]	Tested hardware load-bearing capacity [kg]	Sash width [mm]	Sash height [mm]
ALU-JET S800 Turn-Only hinge/Tilt-Only hinge	11.5	10/14 12/15 14/18	300	max. 1700 [1] max. 2800 [2]	max. 2800 [1] max. 1700 [2]

[1] Turn-Only sash | [2] Tilt-Only sash
For all stated weights and dimensions, please refer to our application diagrams and the manufacturer's profile information!
For more information: www.g-u.com



SPACIO geared turn handle

Geared turn handles

- Available in fork lengths of 22 mm and 33 mm
- With one carrier fork for all standard applications
- With two carrier forks for spreading function on Turn-Only sashes with 90° handle actuation angle
- Optionally with removable service handles
- Optionally tested in accordance with EN 1627



BELCANTO turn handle with insertable gear

Turn handles in combination with insertable gear

- Extensive range of designs and surface finishes
- Optional versions:
 - lockable, for Tilt-First function
 - lockable with key or push-button
 - removable service handles
 - tested in accordance with EN 13126-3
 - tested in accordance with EN 1627
- Insertable gear:
 - optionally with mishandling device
 - optionally with anti-drill plate and connecting rod fixing for increased burglar resistance up to RC3 according to EN 1627

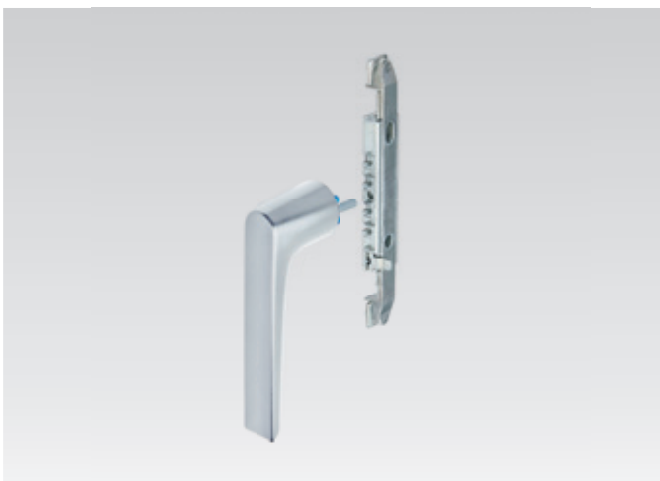

Rosette-free turn handle with insertable gear

Rosette-free turn handles with insertable gear

- Turn handles without visible substructure for high design demands in projects
- Optional versions:
 - lockable, for Tilt-First function
 - lockable with key
- Installation without milling work on the aluminium profile
- Insertable gear:
 - with mishandling device



Parallel-Projecting hardware

The special solution for sashes with weights up to 400 kg, opening widths up to 250 mm and sash heights up to 5000 mm. Parallel-Projecting windows can be created with a comprehensive range of GU stays for all frame materials, such as timber, PVC, aluminium and timber/aluminium.

Turn-Only window hardware

Today's facades, with floor-to-ceiling glazing, are a challenge for standard hardware. Gretsch-Unitas meets these requirements with specially developed hinges for Turn-Only sashes. They are concealed in the rebate and can bear sash weights of up to 350 kg.

Projecting Top-Hung hardware

This hardware range offers a number of different Projecting Top-Hung friction stays with opening angles from 20° to 50°. Sashes can be made to a height of 2500 mm. Projecting Top-Hung windows can be made with GU stays for all frame materials, such as timber, PVC, aluminium and timber/aluminium

Special constructions

Our specialists have developed innovative opening mechanisms to meet individual customer requirements regarding ventilation elements in building envelopes. We draw on our many years of experience and creative ideas to produce solutions tailored to each project.

Possible constructions / solutions with Parallel-Projecting windows

Designation Parallel-Projecting friction stay	Max. sash weight* [kg]	Sash height [mm]	Sash width [mm]	Opening width [mm]	
				manual	motor-driven
PAS350	100	350– 750	350–2000	150	180
PAS450	100	450–1000	450–2000	180	250
PAS670	200	670–1500	670–2000	150	180
PAS930	200	930–2000	930–2000	180	250
PAS1135	200	1400–2100	1400–2000	180	250

*Higher weights are possible if required

Possible constructions / solutions with Turn-Only windows

Designation	Max. sash weight [kg]	Sash height [mm]	Sash width [mm]	Opening width [°]
Concealed Turn-Only hinge	350	425–3500	350–1600	95
Stainless steel Turn-Only hinge	200	430–2800	450–1400	180

Possible constructions / solutions with Projecting Top-Hung windows

Designation Projecting Top-Hung friction stay	Max. sash weight [kg]	Sash height [mm]	Sash width [mm]	Opening width [°]
SKS40	40	276– 640	450–2500	50
SKS50	50	640– 800	450–2500	50
SKS65	65	800–1100	450–2500	50
SKS65H	100	600–1100	450–2500	30
SKS100	100	1100–1500	520–2500	45
SKS100H	100	1500–2000	520–2500	20
SKS180	180	2000–2500	520–2500	20



WINDOW TECHNOLOGY
DOOR TECHNOLOGY
AUTOMATIC ENTRANCE SYSTEMS
BUILDING MANAGEMENT SYSTEMS

Gretsch-Unitas GmbH
Baubeschläge
Johann-Maus-Str. 3
71254 Ditzingen
Germany
Tel. + 49 7156 301-0
Fax + 49 7156 301-77980

BKS GmbH
Heidestr. 71
42549 Velbert
Germany
Tel. + 49 2051 201-0
Fax + 49 2051 201-9733

www.g-u.com

WP00374-04-1-2 03/2024 Printed in Germany



Copyright notice

© All illustrations and texts in this publication are protected by copyright. Unless otherwise stated on the image, the rights belong to the Gretsch-Unitas group. Any use of copyright protected materials without the consent of the holder of the rights is prohibited.

Publisher

Gretsch-Unitas GmbH Baubeschläge | Johann-Maus-Str. 3 | 71254 Ditzingen | Germany
Tel. + 49 7156 301-0 | Fax + 49 7156 301-293 | www.g-u.com

Securing technology for you

