

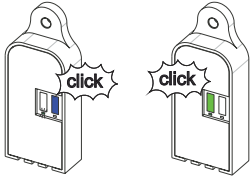

Technische Daten



	
Batterie	Typ CR 2032
Funksystem	868 MHz BKS-System AES-128-Bit-Verschlüsselung mit Challenge Response-Verfahren
Abmessungen	35 x 35 x 10 mm

Quick Start

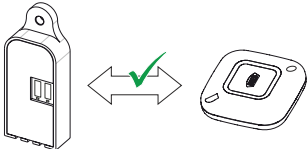
Pairing von Funk-Handsender und Funkempfänger

<p>① Funkempfänger in den Service-Modus bringen:</p>  <p>Kanal "blau" Kanal "grün" Taste für den gewünschten Kanal kurz betätigen - die grüne LED leuchtet dauerhaft.</p>	<p>②</p>  <p>Taste am Funk-Handsender innerhalb von 30 s kurz betätigen.</p>	<p>③ Funk-Handsender und Funkempfänger sind gepairt.</p>  <p>Wurde innerhalb von 30 s kein Funk-Handsender erkannt, wird der Service-Modus beendet.</p>
------------------------------------------------------------------------------------------------------------------------------------------------------------------------------------------------------------------------------------------------------------------	------------------------------------------------------------------------------------------------------------------------------------------------------------------	----------------------------------------------------------------------------------------------------------------------------------------------------------------------------------------------------------------------------------------------

Mit einem kurzen Tastendruck wird jetzt ein Zutritt bzw. die Schaltfunktion des gepairten Funkempfängers ausgelöst.

 <p>berechtigt</p>	 <p>kein Pairing</p>	 <p>kein Empfänger in Reichweite</p>
-------------------------------------------------------------------------------------------------------	----------------------------------------------------------------------------------------------------------	---------------------------------------------------------------------------------------------------------------------------

Zum Löschen eines Pairings verwenden Sie bitte das Funktionsmenü des Funk-Handsenders.



Weitere Funktionen



C59501183

Der Funk-Handsender verfügt über weitere Funktionen, die Sie über ein Funktionsmenü abrufen können. Weitere Informationen hierzu finden Sie in der Montage- und Bedienungsanleitung des Funkempfängers (B-55280-02-0-6).

Batteriewechsel

Nimmt die Funkreichweite des Systems ab, empfehlen wir eine Prüfung des Batterie-Status über das Funktionsmenü.

Um die Batterie zu wechseln, muss das Gehäuse geöffnet werden. Hierzu eignet sich ein Schlitzschraubendreher mit einer empfohlenen Größe von 0,5 x 3,0 mm.

Setzen Sie den Schraubendreher in die Vertiefung an der Seite des Gehäuses an. Klappen Sie den Schraubendreher vorsichtig nach unten und öffnen Sie den Deckel.

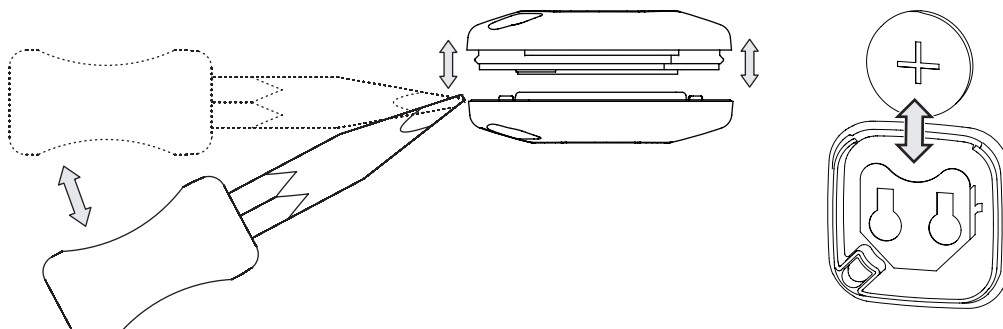

Bei falsch eingelegter Batterie besteht Explosionsgefahr.

Verwenden Sie ausschließlich Batterien des selben oder gleichwertigen Typs!

Rücksetzen auf Werkseinstellungen

Sie können den Funk-Handsender auf Werkseinstellungen zurücksetzen. Entfernen Sie kurzzeitig die Batterie. Halten Sie die Taste beim Einlegen der Batterie für ca. 3 s gedrückt. Der Funk-Handsender löscht dabei alle Pairings und befindet sich im Betrieb „Benutzer-Funk-Handsender“.

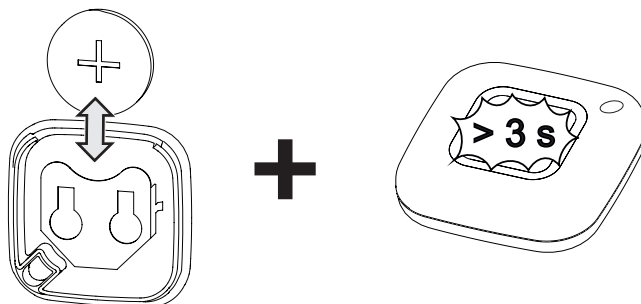

Der Funk-Handsender ist als Elektronikschrott an öffentlichen Rücknahmestellen und Wertstoffhöfen zu entsorgen. Die Verpackung ist separat zu entsorgen.

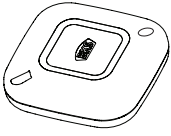

B-55281-01-0-9 1-channel handheld radio transmitter

Technical data

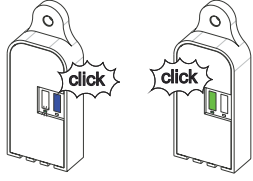

	
Battery	Type CR 2032
Radio system	868 MHz BKS system AES 128-bit encryption with Challenge Response procedure
Dimensions	35 x 35 x 10 mm

Quick Start

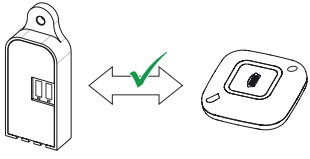
Pairing of handheld radio transmitter and radio receiver

<p>① Putting the radio receiver in the Service mode:</p>  <p>"Blue" channel "Green" channel Briefly press the button for the required channel - the green LED lights up continuously.</p>	<p>②</p>  <p>Briefly press the button on the handheld radio transmitter within 30 s.</p>	<p>③ The handheld radio transmitter and radio receiver are now paired.</p>  <p>If a handheld radio transmitter is not detected within 30 s, the Service mode is cancelled.</p>
----------------------------------------------------------------------------------------------------------------------------------------------------------------------------------------------------------------------------------------------------------------------------------	------------------------------------------------------------------------------------------------------------------------------------------------------------------------------	---------------------------------------------------------------------------------------------------------------------------------------------------------------------------------------------------------------------------------------------------------------------

If the button is pressed briefly, access is now granted or the switching function of the paired radio receiver is triggered.

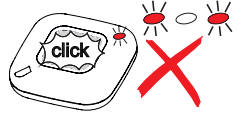
 <p>authorised</p>	 <p>no pairing</p>	 <p>no receiver within range</p>
-------------------------------------------------------------------------------------------------------	--------------------------------------------------------------------------------------------------------	-----------------------------------------------------------------------------------------------------------------------

To cancel a pairing, use the function menu of the handheld radio transmitter.



More functions



C59501183

The handheld radio transmitter features more functions which you can call up via a function menu. For further details see our installation and operating instructions of the radio receiver (B-55280-02-0-6).

Battery change

If the radio range of the system decreases, we recommend to check the battery level via the function menu.

The housing must be opened to change the battery.

A slot-head screwdriver size 0.5 x 3.0 mm is recommended.

Apply the head of the screwdriver in the recess at the side of the housing.

Carefully turn the screwdriver towards bottom and open the housing.

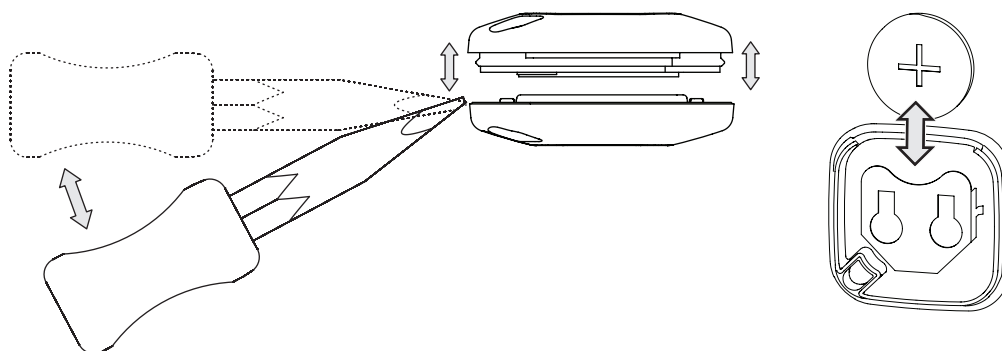

Restore factory settings

You can change the handheld radio transmitter to factory settings. Remove briefly the battery. Hold the button for approx. 3s pressed when inserting the battery. The handheld radio transmitter deletes all pairings and will be in "User handheld radio transmitter" mode.

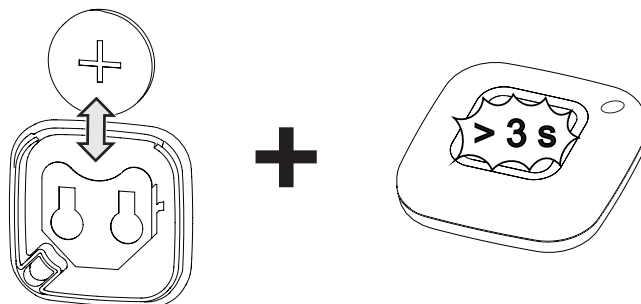



B-55281-01-0-9 Émetteur radio manuel monocanal

Caractéristiques techniques

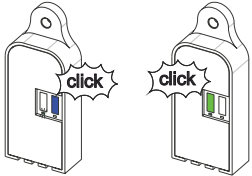

Batterie	Type CR 2032
Système radio	Système BKS 868 MHz Codage AES 128 bits avec procédure Challenge Response
Dimensions	35 x 35 x 10 mm

Démarrage rapide

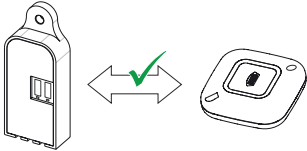
Appairage de l'émetteur radio manuel avec le récepteur radio

<p>① Mettre le récepteur radio en mode Service :</p>  <p>Canal « bleu » Canal « vert » Actionner brièvement le bouton-poussoir pour sélectionner le canal souhaité - la LED verte s'allume en continu.</p>	<p>②</p>  <p>Actionner brièvement le bouton-poussoir de l'émetteur radio manuel dans les 30 s qui suivent.</p>	<p>③ L'émetteur radio manuel et le récepteur radio sont maintenant appairés.</p>  <p>Si aucun émetteur radio manuel n'est reconnu dans les 30 s qui suivent, le mode Service est interrompu.</p>
---------------------------------------------------------------------------------------------------------------------------------------------------------------------------------------------------------------------------------------------------------------------------------------------------	----------------------------------------------------------------------------------------------------------------------------------------------------------------------------------------------------	---------------------------------------------------------------------------------------------------------------------------------------------------------------------------------------------------------------------------------------------------------------------------------------

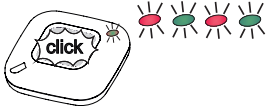
Une brève pression sur le bouton permet à présent d'avoir accès au récepteur radio appairé ou de déclencher sa commutation.

 <p>autorisé</p>	 <p>aucun appairage</p>	 <p>aucun récepteur à portée</p>
-----------------------------------------------------------------------------------------------------	-------------------------------------------------------------------------------------------------------------	-----------------------------------------------------------------------------------------------------------------------

Pour supprimer un appairage, merci d'utiliser le menu des fonctions de l'émetteur radio manuel.



Fonctions supplémentaires



C59501183

L'émetteur radio manuel dispose de fonctions supplémentaires consultables via le menu des fonctions. Vous trouverez des informations supplémentaires à ce sujet dans la notice de montage et d'utilisation du récepteur radio (B-55280-02-0-6).

Remplacement de la batterie

Si la portée radio du système décroît, nous recommandons d'effectuer un contrôle de l'état de la pile au moyen du menu des fonctions.

Pour remplacer la batterie, ouvrir le boîtier.

Pour ce faire, il convient d'utiliser un tournevis plat aux dimensions recommandées de 0,5 x 3,0 mm.

Insérer le tournevis dans le renforcement sur le côté du boîtier.

Relever le tournevis avec précaution et ouvrir le couvercle.

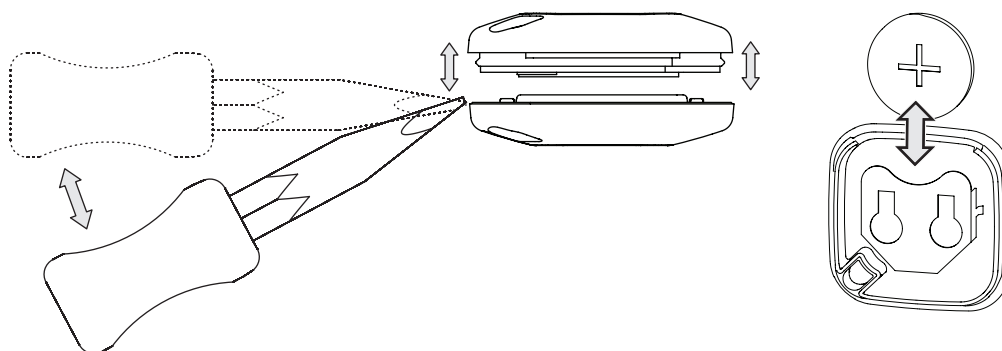

Remise à la configuration d'usine

Vous pouvez remettre l'émetteur radio manuel à la configuration d'usine. Enlever brièvement la batterie. En plaçant la batterie, maintenir le bouton-poussoir enfoncé pendant env. 3 s. L'émetteur radio manuel efface alors tous les appairages et retourne en mode de fonctionnement « Émetteur radio utilisateur ».

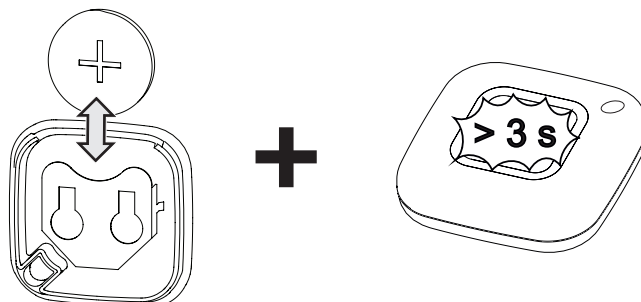

B-55281-01-0-9 Emisor manual de radio de 1 canal

Datos técnicos

Batería	Tipo CR 2032
Sistema de radio	Sistema BKS de 868 MHz Cifrado AES de 128 bits con protocolo desafío-respuesta (Challenge Response)
Dimensiones	35 x 35 x 10 mm

Inicio rápido

Emparejamiento del emisor manual de radio y el radioreceptor

<p>①</p> <p>Ajuste el radioreceptor en el modo de servicio:</p> <p>Canal «azul» Canal «verde» Pulse la tecla del canal deseado; el LED verde está encendido.</p>	<p>②</p> <p>Pulse brevemente la tecla del emisor manual de radio dentro de los 30 s siguientes.</p>	<p>③</p> <p>El emisor manual de radio y el radioreceptor están emparejados.</p> <p>Si no se detecta ningún emisor manual de radio durante los siguientes 30 s, se abandonará el modo de servicio.</p>
----------------------------------------------------------------------------------------------------------------------------------------------------------------------	-----------------------------------------------------------------------------------------------------	-------------------------------------------------------------------------------------------------------------------------------------------------------------------------------------------------------

Ahora, pulsando brevemente la tecla se accederá o se activará la función de conmutación del radioreceptor emparejado.

<p>autorizado</p>	<p>no hay emparejamiento</p>	<p>no hay receptores dentro del alcance</p>
-------------------	------------------------------	---------------------------------------------

Para eliminar un emparejamiento utilice el menú de funciones del emisor manual de radio.



Otras funciones



C59501183

El emisor manual de radio dispone de otras funciones que pueden activarse en el menú de funciones. Para ello encontrará más información en el manual de instrucciones y de montaje del radioreceptor (B-55280-02-0-6).

Cambio de la batería

Si disminuye el alcance de radio del sistema, aconsejamos comprobar el estado de la batería a través del menú de funciones.

Para cambiar la batería debe abrirse la caja.

Para ello se recomienda el uso de un destornillador plano de 0,5 x 3,0 mm.

Coloque el destornillador en la ranura del lateral de la caja.

Bascule con cuidado el destornillador hacia abajo y abra la tapa.

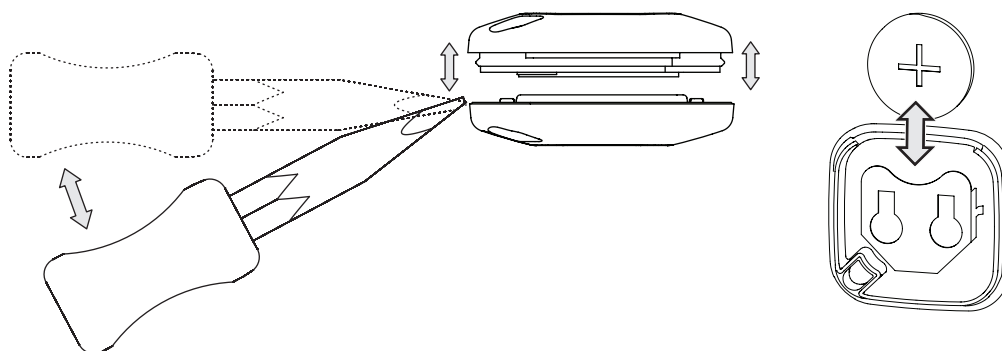

Ajustes de fábrica

Puede restaurar los ajustes de fábrica del emisor manual. Retire brevemente la batería. Al colocar la batería, mantenga pulsada la tecla durante aprox. 3 s. Al hacerlo se eliminan todos los emparejamientos del emisor manual de radio y se encuentra en el modo "emisor manual de radio del usuario"

